

POLICE and FIRE STATION LOCKERS

Salsbury Industries offers a comprehensive range of top-notch lockers designed specifically for police and fire stations. Constructed of premium quality materials, Salsbury lockers are available in various sizes, colors and configurations to meet your specific needs. Equipped with advanced locking features, our lockers guarantee the safety and security of your staff's belongings. Salsbury police and fire station lockers can be ordered by phone or online at www.lockers.com.



People Committed to Quality Since 1936®

POLICE and FIRE STATION LOCKERS

Standard Metal Lockers - 12" Wide



STANDARD METAL LOCKERS - 12" WIDE

- Constructed of 16 gauge steel and feature a durable powder coated finish available in gray, tan or blue.
- Ideal for police and fire stations, health clubs, locker rooms, sports and athletic facilities or wherever a professional environment is desired.
- 5 and 6 foot high lockers have compartment sizes that are 12" wide, and 12", 15" or 18" deep.
- Units include a lift up handle and recessed hasp for added security and can accommodate built-in combination or key locks and combination or key padlocks.

CONFIGURATIONS

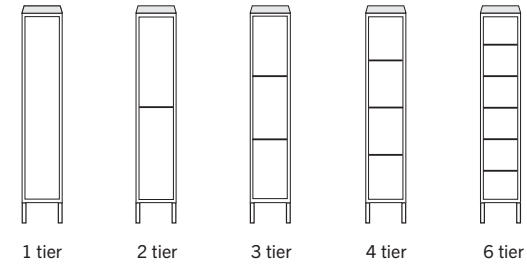

LOCKER OPTIONS

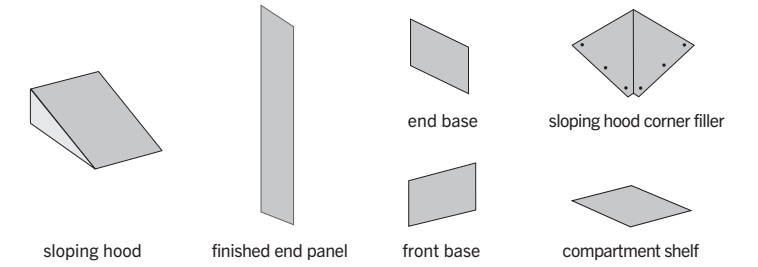

COLOR OPTIONS



LOCK OPTIONS / NUMBER PLATES

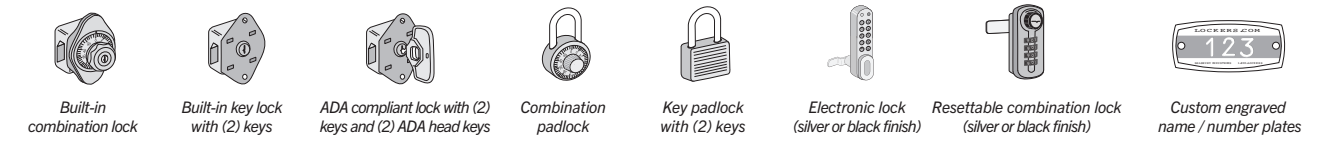

DISPLAYED WITH OPTIONAL FINISHED END PANEL, SLOPING HOOD, FRONT AND END BASES

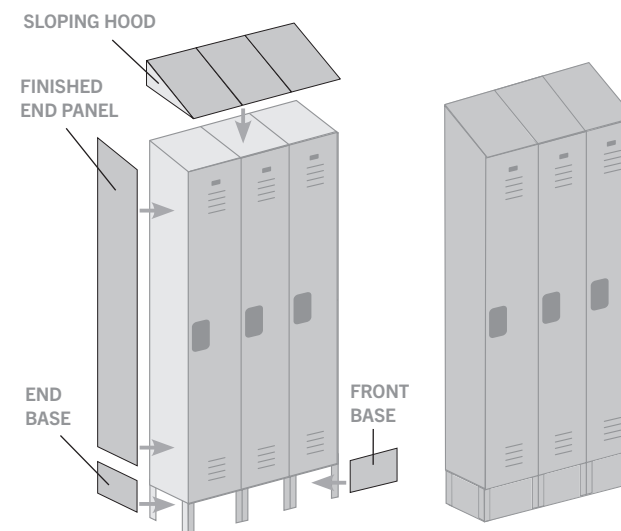

Online Resources

- Product Information
- 3D Revit / BIM Models
- Detailed Specifications
- Technical Drawings
- Augmented Reality (AR) Models
- Installation Instructions
- AutoCAD Drawings

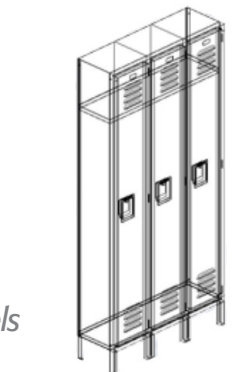

Visit: www.lockers.com/Architectural-Resources

POLICE and FIRE STATION LOCKERS

Standard Metal Lockers - 15" Wide



STANDARD METAL LOCKERS - 15" WIDE

- Constructed of 16 gauge steel and feature a durable powder coated finish available in gray, tan or blue.
- Ideal for police and fire stations, health clubs, locker rooms, sports and athletic facilities or wherever a professional environment is desired.
- 25% wider than 12" wide standard lockers and compartment size that is 15" wide, and 15" or 18" deep.
- Units include a lift up handle and recessed hasp for added security and can accommodate built-in combination or key locks and combination or key padlocks.

CONFIGURATIONS

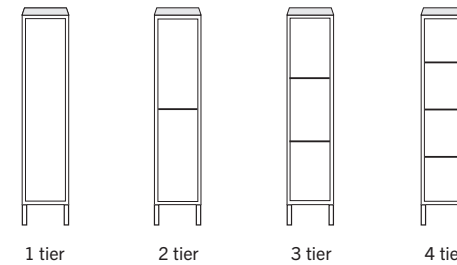

LOCKER OPTIONS

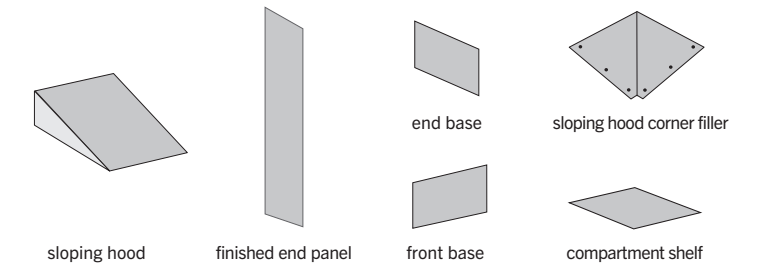

COLOR OPTIONS



LOCK OPTIONS / NUMBER PLATES

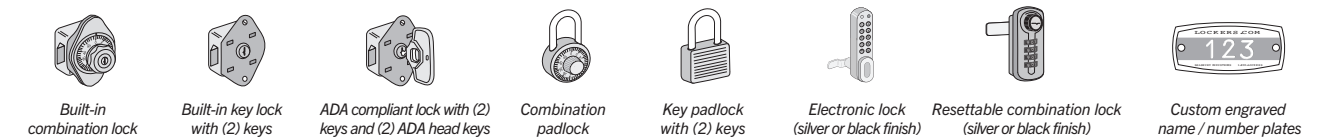

DISPLAYED WITH OPTIONAL FINISHED END PANEL, SLOPING HOOD, FRONT AND END BASES

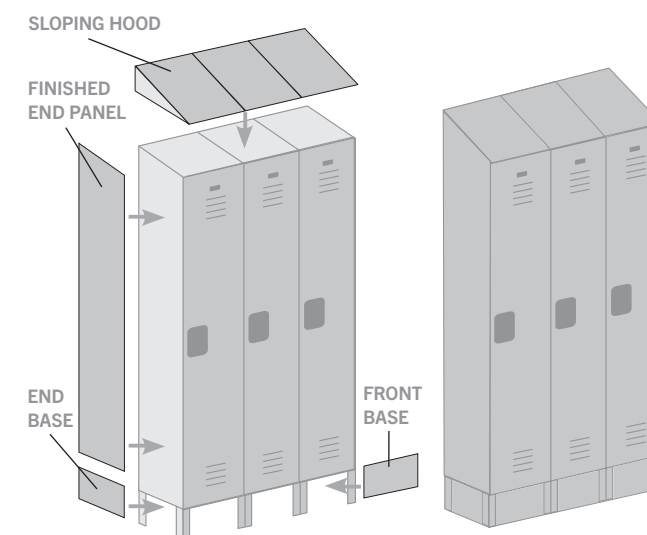

Online Resources

- Product Information
- 3D Revit / BIM Models
- Detailed Specifications
- Technical Drawings
- Augmented Reality (AR) Models
- Installation Instructions
- AutoCAD Drawings

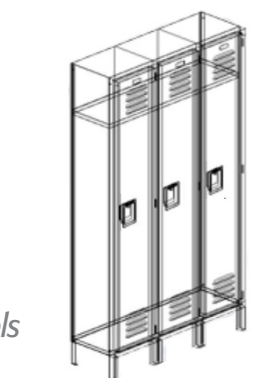

Visit: www.lockers.com/Architectural-Resources

POLICE and FIRE STATION LOCKERS

Standard Metal Lockers - 18" Wide



STANDARD METAL LOCKERS - 18" WIDE

- Constructed of 16 gauge steel and feature a durable powder coated finish available in gray, tan or blue.
- Ideal for police and fire stations, health clubs, locker rooms, sports and athletic facilities or wherever a professional environment is desired.
- 50% wider than 12" wide standard lockers and compartment size that is 18" wide, and 18" or 21" deep.
- Units include a lift up handle and recessed hasp for added security and can accommodate built-in combination or key locks and combination or key padlocks.

CONFIGURATIONS

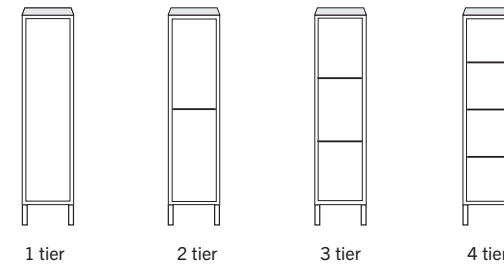

LOCKER OPTIONS

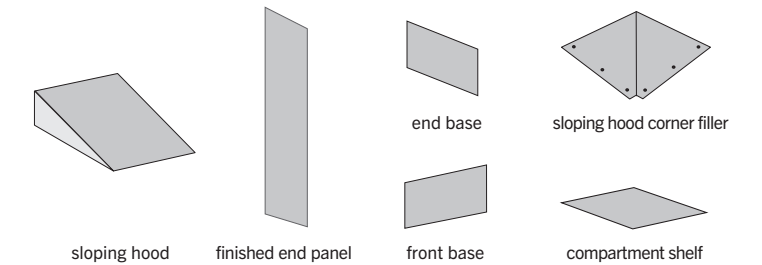

COLOR OPTIONS



LOCK OPTIONS / NUMBER PLATES

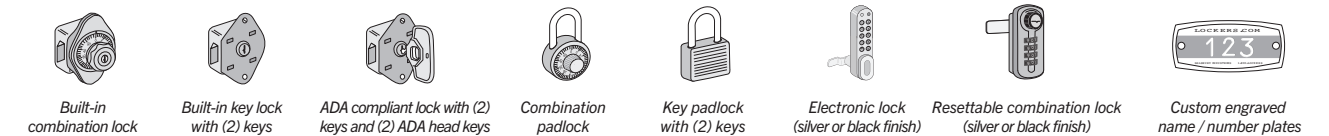

DISPLAYED WITH OPTIONAL FINISHED END PANEL, SLOPING HOOD, FRONT AND END BASES

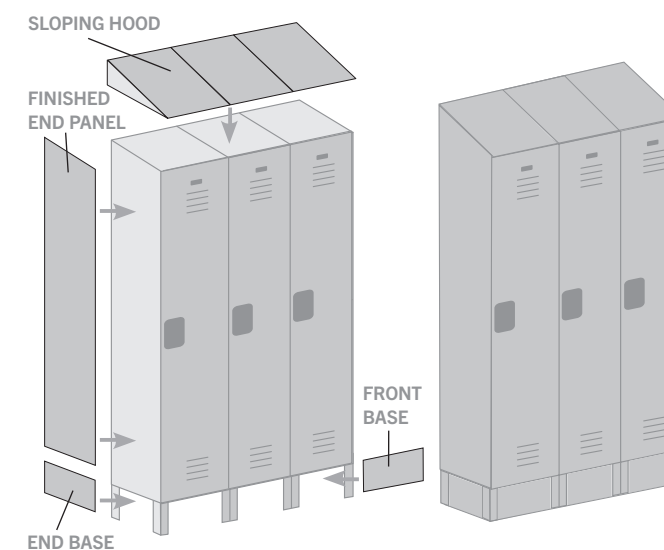

Online Resources

- Product Information
- 3D Revit / BIM Models
- Detailed Specifications
- Technical Drawings
- Augmented Reality (AR) Models
- Installation Instructions
- AutoCAD Drawings

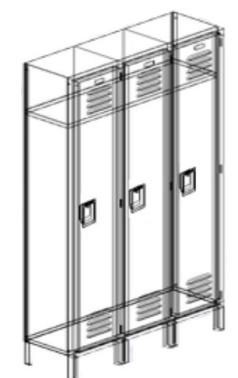

Visit: www.lockers.com/Architectural-Resources

POLICE and FIRE STATION LOCKERS

Vented Metal Lockers - 12" Wide



VENTED METAL LOCKERS - 12" WIDE

- Constructed of 16 gauge steel and feature a durable powder coated finish available in gray, tan or blue.
- Ideal for police and fire stations, locker rooms, employee changing rooms, gyms and many other applications where visibility and maximum airflow is needed.
- 5 and 6 foot high lockers have compartment sizes that are 12" wide, and 12", 15" or 18" deep.
- Units include a lift up handle and recessed hasp for added security and can accommodate built-in combination or key locks and combination or key padlocks.

CONFIGURATIONS

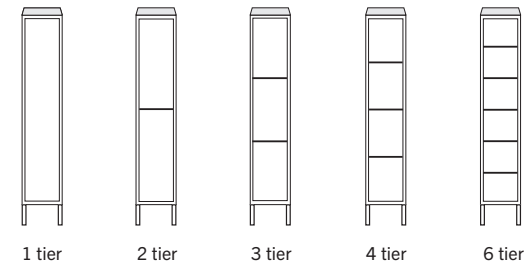

LOCKER OPTIONS

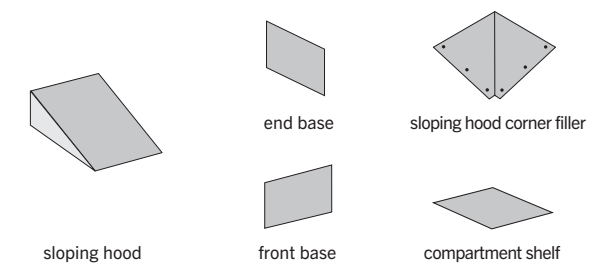

COLOR OPTIONS



LOCK OPTIONS / NUMBER PLATES

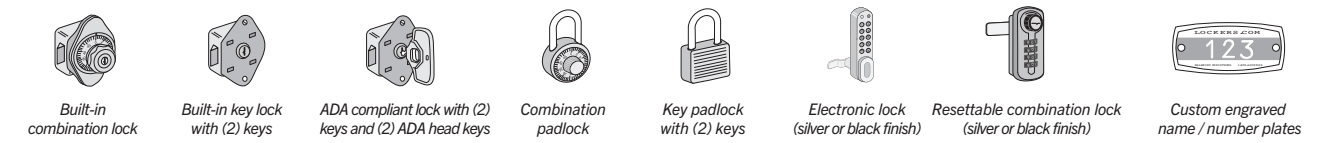

DISPLAYED WITH OPTIONAL SLOPING HOOD, FRONT AND END BASES

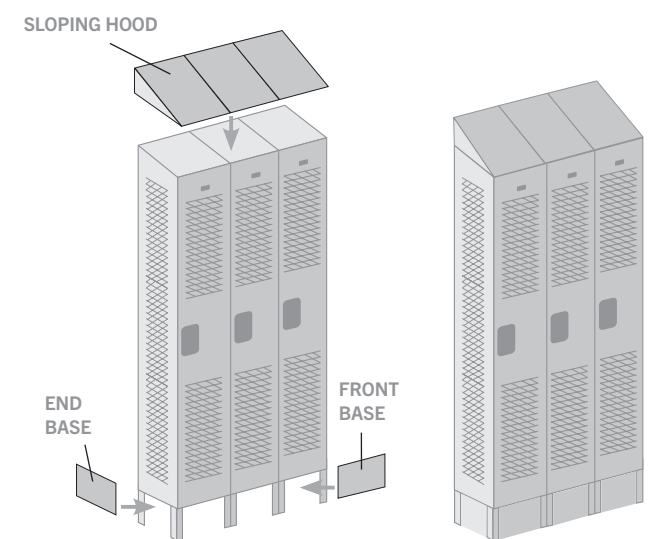

Online Resources

- Product Information
- 3D Revit / BIM Models
- Detailed Specifications
- Technical Drawings
- Augmented Reality (AR) Models
- Installation Instructions
- AutoCAD Drawings

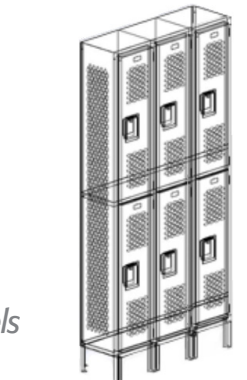

Visit: www.lockers.com/Architectural-Resources

POLICE and FIRE STATION LOCKERS

Vented Metal Lockers - 15" Wide

VENTED METAL LOCKERS - 15" WIDE

- Constructed of 16 gauge steel and feature a durable powder coated finish available in gray, tan or blue.
- Ideal for police and fire stations, locker rooms, employee changing rooms, gyms and many other applications where visibility and maximum airflow is needed.
- 5 and 6 foot high lockers have compartment sizes that are 15" wide, and 15" or 18" deep.
- Units include a lift up handle and recessed hasp for added security and can accommodate built-in combination or key locks and combination or key padlocks.



CONFIGURATIONS

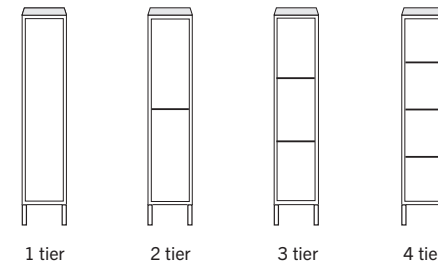

LOCKER OPTIONS

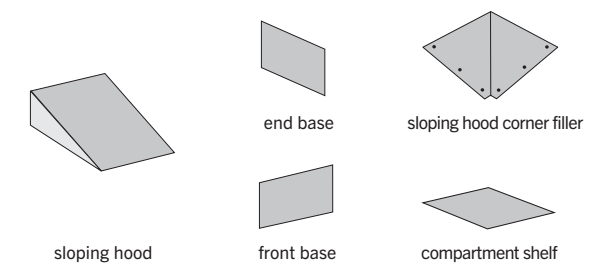

COLOR OPTIONS



LOCK OPTIONS / NUMBER PLATES

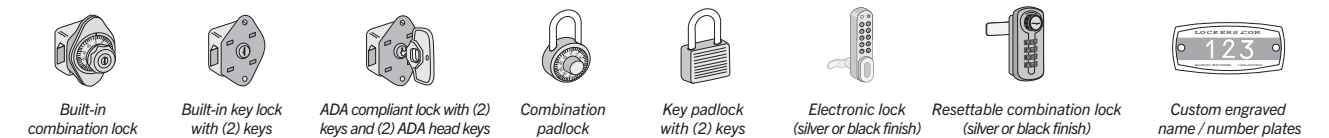

DISPLAYED WITH OPTIONAL SLOPING HOOD, FRONT AND END BASES

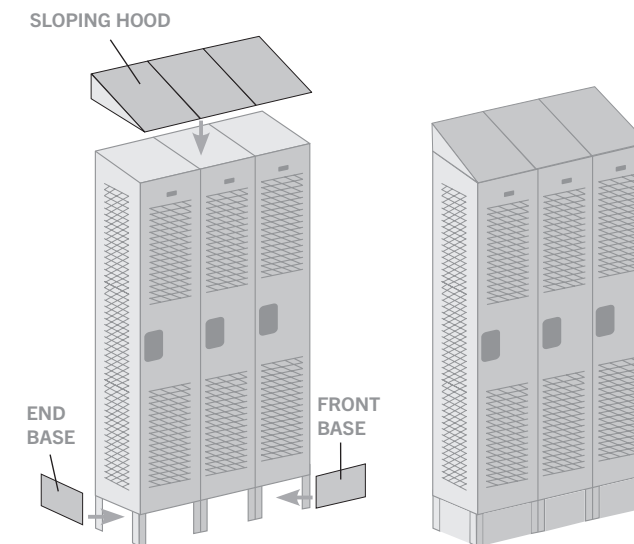

Online Resources

- Product Information
- 3D Revit / BIM Models
- Detailed Specifications
- Technical Drawings
- Augmented Reality (AR) Models
- Installation Instructions
- AutoCAD Drawings

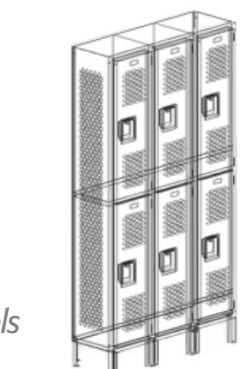

Visit: www.lockers.com/Architectural-Resources

POLICE and FIRE STATION LOCKERS

Open Access Metal Lockers



OPEN ACCESS METAL LOCKERS

- Constructed of 16 gauge steel and feature a durable powder coated finish available in gray, tan or blue.
- Ideal for police and fire stations, high schools, locker rooms, sports facilities and many other applications where visibility and maximum airflow is needed.
- Units are 24" wide, 6 feet high and 18" or 24" deep.
- Units also feature 2 steel coat hooks, a coat rod and a 14" high foot locker with a hinged lid and recessed padlock hasp for secure storage.

COLOR OPTIONS



LOCK OPTIONS / NUMBER PLATES



LOCKER BENCHES

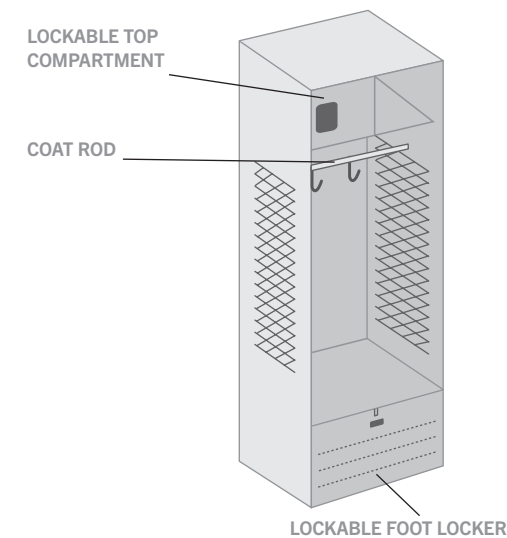
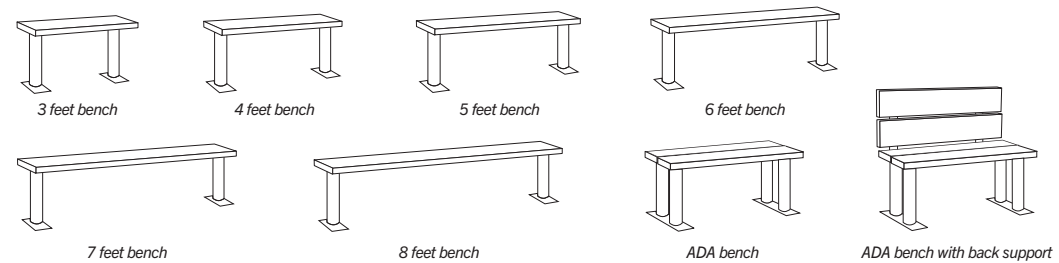

Online Resources

- *Product Information*
- *3D Revit / BIM Models*
- *Detailed Specifications*
- *Technical Drawings*
- *Augmented Reality (AR) Models*
- *Installation Instructions*
- *AutoCAD Drawings*

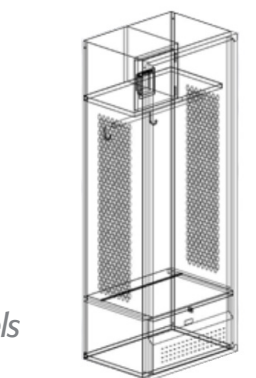

Visit: www.lockers.com/Architectural-Resources

POLICE and FIRE STATION LOCKERS

Gear Metal Lockers



GEAR METAL LOCKERS

- Constructed of 16 gauge steel and feature a durable powder coated finish available in gray, tan or blue.
- Ideal for high schools, middle schools, colleges, locker rooms, sports facilities, police and fire stations and many other applications where visibility and maximum airflow is needed.
- Ventilated doors open from left to right and are attached with 4 heavy duty hinges allowing for smooth operation.
- Units are 24" wide, 6 feet high and 18" or 24" deep. Units also feature 2 steel coat hooks, a coat rod and a 14" high foot locker with a hinged lid and recessed padlock hasp for secure storage.

COLOR OPTIONS

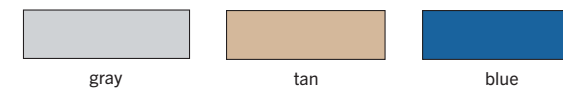

LOCK OPTIONS / NUMBER PLATES



LOCKER BENCHES

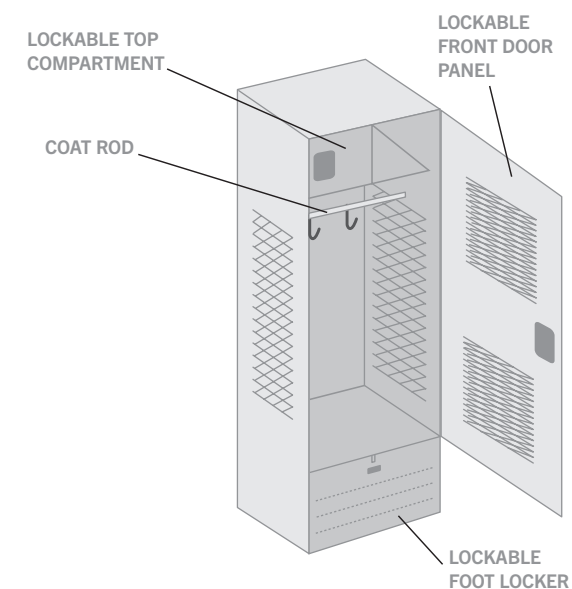
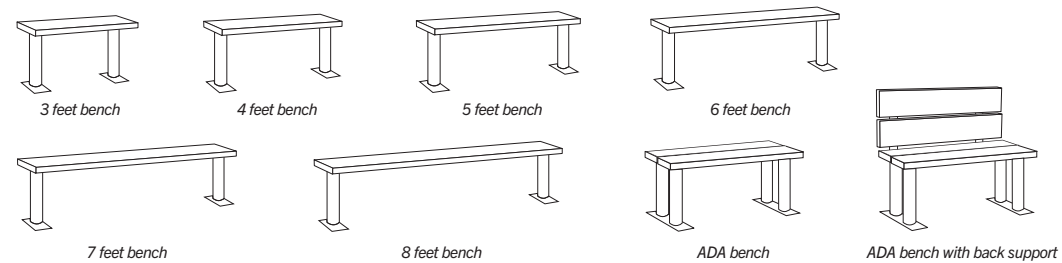

Online Resources

- *Product Information*
- *3D Revit / BIM Models*
- *Detailed Specifications*
- *Technical Drawings*
- *Augmented Reality (AR) Models*
- *Installation Instructions*
- *AutoCAD Drawings*

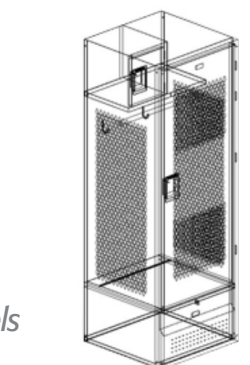

Visit: www.lockers.com/Architectural-Resources

POLICE and FIRE STATION LOCKERS

Designer Open Access Series



DESIGNER OPEN ACCESS LOCKERS

- Constructed of industrial grade particleboard and covered with durable high pressure laminate.
- Ideal for police and fire stations, sports facilities, schools, locker rooms, or wherever a professional environment is needed.
- 14" high foot locker provides comfortable seating and secure equipment storage.
- The top compartment features a 12" wide x 3/4" deep door with heavy duty concealed hinges and a lift up handle and recessed hasp for added security.

TOP AND SIDE OPTIONS

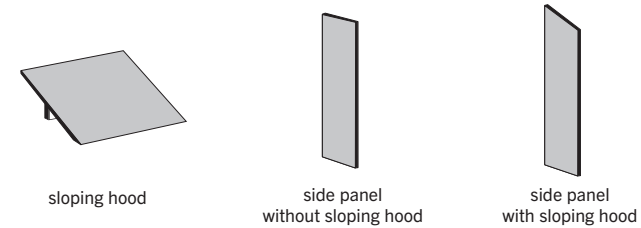

COLOR OPTIONS



Custom colors - 25% upcharge (minimum fifteen (15) frames) To view all colors visit: www.lockers.com/customdesignerlockers

LOCK OPTIONS / NUMBER PLATES

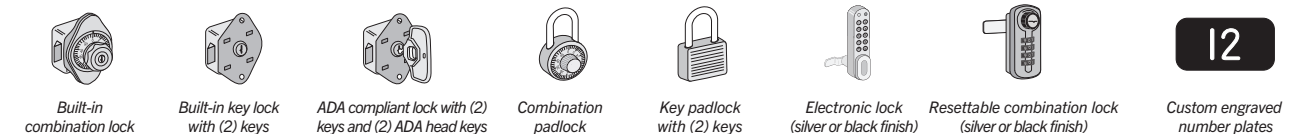

DISPLAYED WITH OPTIONAL SIDE PANEL AND SLOPING HOOD

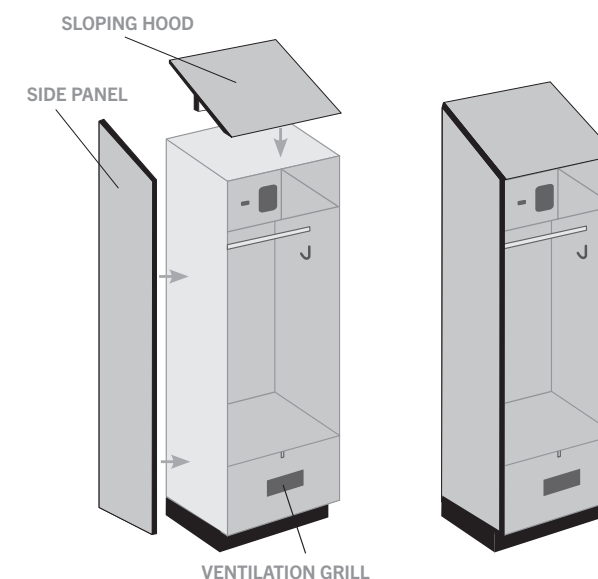

Online Resources

- Product Information
- 3D Revit / BIM Models
- Detailed Specifications
- Technical Drawings
- Augmented Reality (AR) Models
- Installation Instructions
- AutoCAD Drawings



Visit: www.lockers.com/Architectural-Resources

POLICE and FIRE STATION LOCKERS

Designer Wood Gear Series



DESIGNER WOOD GEAR LOCKERS

- Constructed of industrial grade particleboard and covered with durable high pressure laminate.
- Ideal for police and fire stations, sports facilities, schools, locker rooms, or wherever a professional environment is needed.
- Units feature a ventilated front door that opens from left to right with four (4) heavy duty concealed hinges.
- Units are 24" wide, 6 feet high and 18" or 24" deep. The top compartment features a 12" wide x 3/4" deep door with heavy duty concealed hinges a lift up handle and recessed hasp for additional security.

TOP AND SIDE OPTIONS

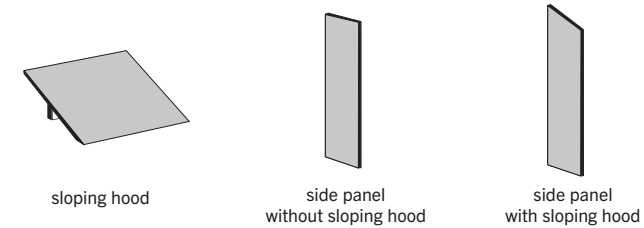

COLOR OPTIONS

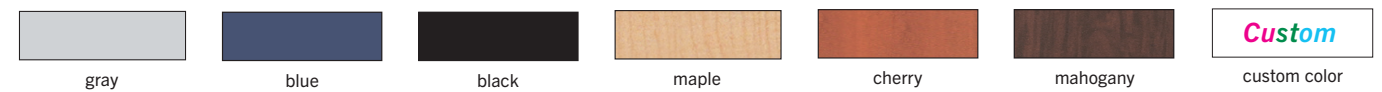

Custom colors - 25% upcharge (minimum fifteen (15) frames) To view all colors visit: www.lockers.com/customdesignerlockers

LOCK OPTIONS / NUMBER PLATES

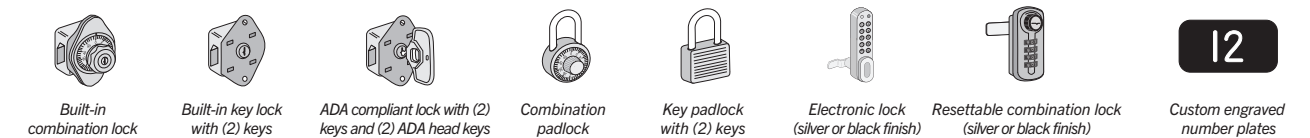

DISPLAYED WITH OPTIONAL SIDE PANEL AND SLOPING HOOD

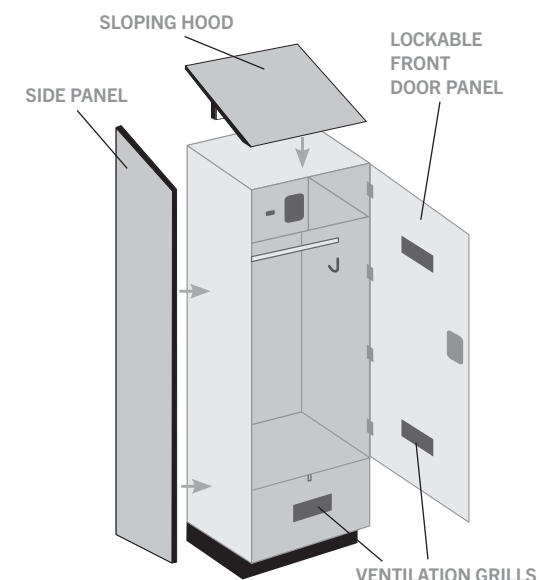

Online Resources

- Product Information
- 3D Revit / BIM Models
- Detailed Specifications
- Technical Drawings
- Augmented Reality (AR) Models
- Installation Instructions
- AutoCAD Drawings



Visit: www.lockers.com/Architectural-Resources

MANUFACTURING SINCE 1936

The Industry Leader in Quality Lockers



ORDER FACTORY DIRECT

Large Inventory and Fast Shipping



SALSBURY INDUSTRIES

Contact us to learn more about
Salsbury Police and Fire Station Lockers!

Discounts Available!
Contact Us
for a Quote Today!



People Committed to Quality Since 1936®

Salsbury Industries
18300 Central Avenue
Carson CA 90746-4008

phone: 1.800.562.5377

fax: 1.800.562.5399

phone: 1.323.846.6700

fax: 1.323.846.6800

email: salsbury@lockers.com

website: www.lockers.com

